

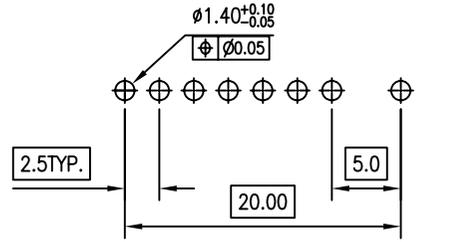

A B C D E F

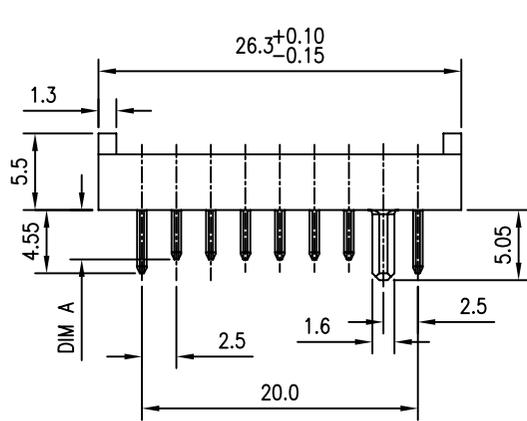

REFERENCE PCB BOARD LAYOUT
VIEW FROM CONNECTOR MOUNTING SIDE
(THICKNESS=0.8~1.2mm)

- NOTES:
- MATERIAL:
 - HOUSING: THERMOPLASTIC, HIGH TEMP., UL94V-0; COLOR:BLACK.
 - CONTACT: COPPER ALLOY
 - FINISH:
 - CONTACT:
 - 5u" Au PLATING ON CONTACT AREA. GOLD FLASH PLATING ON OVERALL.
 - 50u" MIN. NICKEL UNDERPLATING OVERALL.
 - REFLOW SOLDER CAPABLE TO 260°C PER ACES SPEC.
 - SPEC. PLS. REFER TO PS-50966-XXXX-XXX
 - PACKAGE PLS. REFER TO 50966-XXXX-TRP
 - PART NUMBER

50966-008 X X-XXX

NO OF CKT	XXX	Housing Color	Cover	DIM A	DATE CODE
	001	Black	Without	3.55	Without

PACKING: 7:TAPE & REEL
PLATING: B:5u" GOLD ON CONTACT(LEAD FREE)

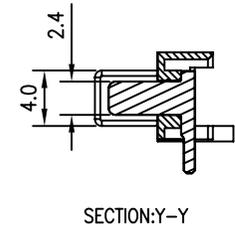
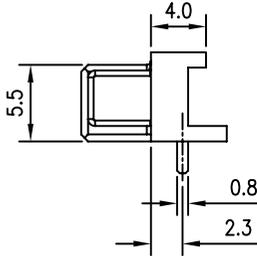
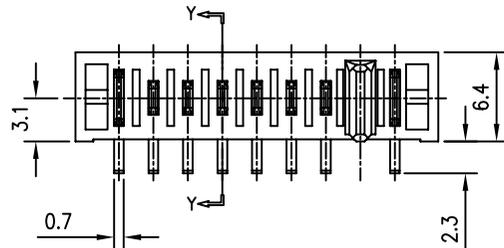

SECTION:Y-Y

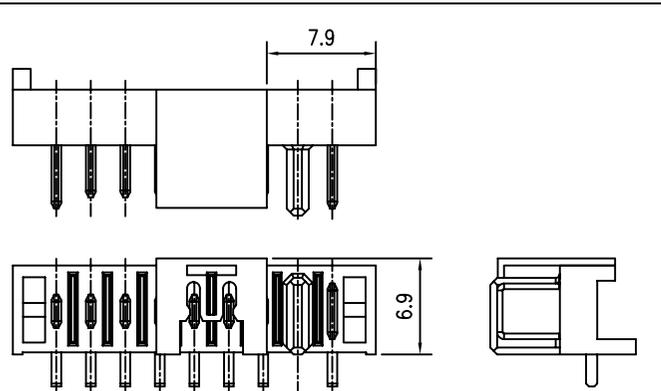
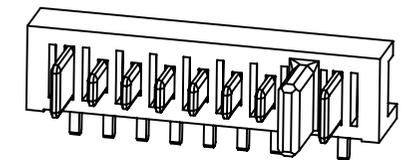

WITH COVER DRAWING

A B C D E F

一般公差 TOLERANCES X ±0.5 XY ±0.15 Y ±0.25 XXX ±0.1 ANGLES ±2°		宏致電子股份有限公司 Aces Electronic Co.,Ltd.	
檢驗尺寸標示 SYMBOLS \oplus \ominus INDICATE CLASSIFICATION DIMENSION \oplus MARK IS CRITICAL DIM. \ominus MARK IS MAJOR DIM.	品名 (TITLE) 2.50mm Pitch Battery Connector TYPE H=6.4mm 圖號 (DWG.NO) 50966-008XX-XXX	製圖 (DR) 16/08/18 JINTAO 審核 (CHKD) BRAVE	核准 (APPD) FRANK
表面處理 (FINISH)	比例 (SCALE) 1:1	單位 (UNITS) mm	張數 (SHEET) 1 OF 2 圖號 (DWG.NO) 50966-008XX-XXX 比例 (SCALE) 1:1 單位 (UNITS) mm 圖號 (DWG.NO) 50966-008XX-XXX
			張數 (SHEET) 1 OF 2 圖號 (DWG.NO) 50966-008XX-XXX 比例 (SCALE) 1:1 單位 (UNITS) mm 圖號 (DWG.NO) 50966-008XX-XXX



A B C D E F

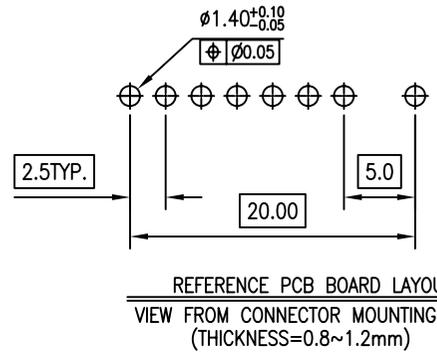
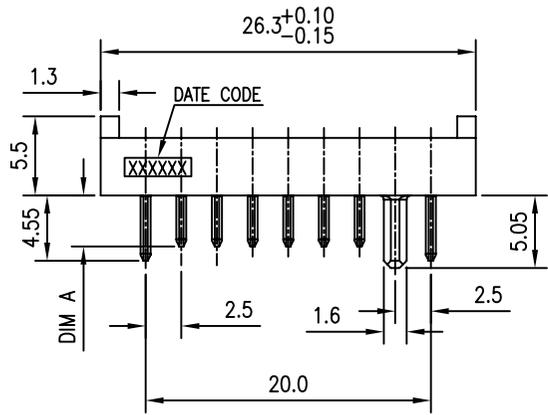

- NOTES:
- MATERIAL:
 - HOUSING: THERMOPLASTIC, HIGH TEMP., UL94V-0; MATERIAL:LCP.
 - TERMINAL: C2680
 - FINISH:
 - CONTACT:
 - 50u" MIN. NICKEL UNDERPLATING OVERALL.
 - T:10u" Au PLATING ON CONTACT AREA.
 - GOLD FLASH PLATING ON OVERALL.
 - REFLOW SOLDER CAPABLE TO 260°C PER ACES SPEC.
 - SPEC. PLS. REFER TO PS-50966-XXXX-002
 - PACKAGE PLS. REFER TO 50966-008XX-XXX-TRAY
 - PART NUMBER

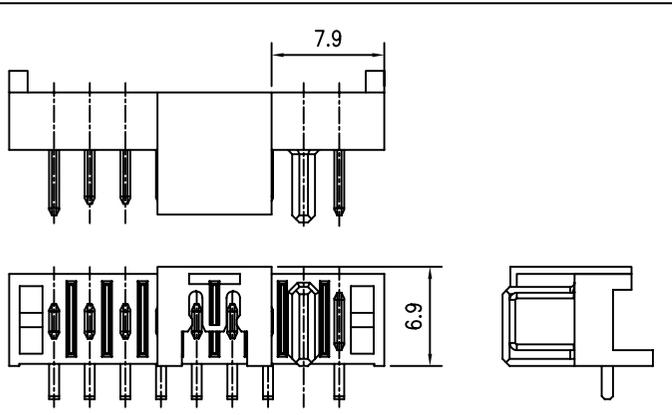
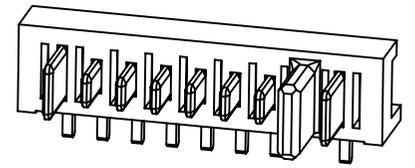
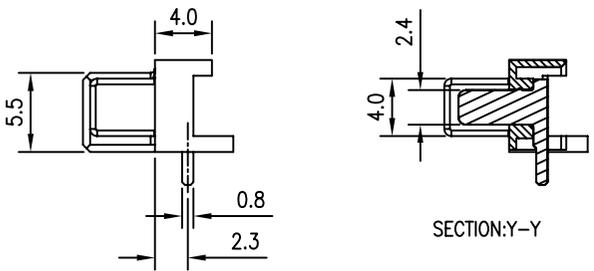
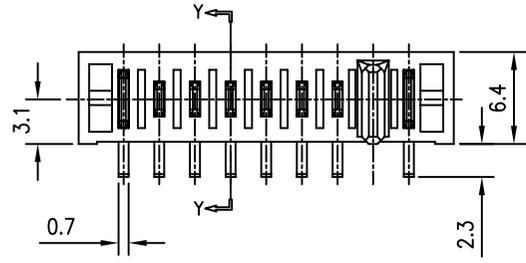
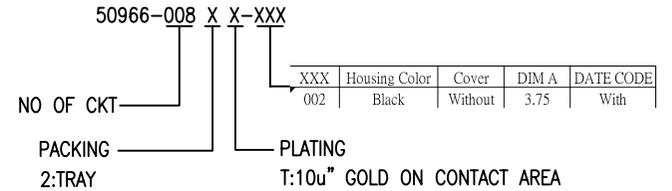

WITH COVER DRAWING

DATE CODE
YEAR:15=2015
MONTH:A(JANUARY)...
DAY:01=01th
ADDRESS:(T=TW,D=DG,K=KS)

15 A 01 K

一般公差 TOLERANCES X: ±0.5 XX: ±0.15 X: ±0.25 XXX: ±0.1 ANGLES: ±2°	宏致電子股份有限公司 Aces Electronic Co.,Ltd.	
檢驗尺寸標示 SYMBOLS (C) (M) INDICATE CLASSIFICATION DIMENSION (C) MARK IS CRITICAL DIM. (M) MARK IS MAJOR DIM.	品名 (TITLE) 2.50mm Pitch Battery Connector TYPE H=6.4mm 圖號 (DWG.NO) 50966-008XX-XXX	製圖 (DR) JINTAO 16/08/18 審核 (CHKD) BRAVE 核准 (APPD) FRANK
表面處理 (FINISH)	比例 (SCALE) 單位 (UNITS) 1:1 mm	張數 (SHEET) 2 OF 2 圖號 (DWG.NO) 50966-008XX-XXX 尺寸 (SIZE) A4 版本 (REV) E

A B C D E F